

DESIGN

Body	Central single flange type
End Connection	EN 1092 PN 6, 10 and 16 ASME B16.5 cl. 150 / B16.47 cl. 150
Face to Face	EN558-1/2 Series 20 API 609 Cat. A
Body Seat	Non replaceable Lining bonded to the body
Shaft Seal Design	O-ring bush
Driving Shaft	With indication for position of the disc
Special Design Options	-

TESTING PROCEDURES

Shell strength test	EN 12266-1, P10 ISO 5208 API 598
Shell tightness test	EN 12266-1, P11 ISO 5208 API 598
Seat tightness test	EN 12266-1, P12, Rate A ISO 5208, Rate A API 598
Operability test	EN 12266-2, F20 ISO 5208 API 598

**OPTIONS**

Anti-Static Design	In accordance with EN 736/3 and API 609
--------------------	-----------------------------------------

FUNCTIONAL CHARACTERISTICS

Application	On/off, regulating, control valve
Design pressure PS	Maximum 16 bar
Design temp. TS	-20°C (-4°F) to +200° (392°F)
Flow velocity	Max. 5 m/s for liquids, max. 50 m/s for gases
Seat tightness rate	Bi-directional - ISO 5208 rate A

MARKING & CERTIFICATION

Marking	EN 19, MSS SP 25
Certification	EN 10204 - 2.2, 3.1, 3.2

PRODUCT DATA

General Description	BUTTERFLY VALVE - Centric rubber lined
Design Code	EN 593
Size Range	DN 350 - 1000, NPS 14"- 40"
Maximum Pressure	16 bar

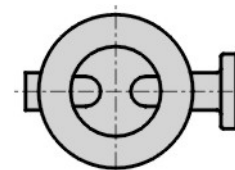
PREFERRED POSITION WHEN INSTALLED IN HORIZONTAL PIPELINE

PARTS LIST - EVMS 350 (14")

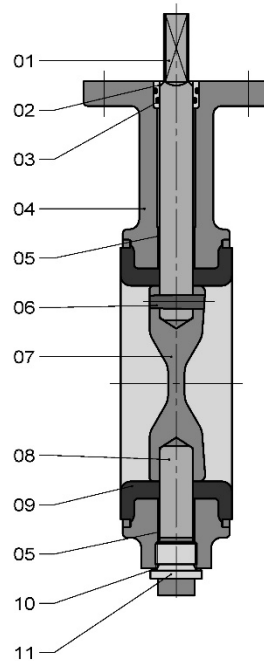

Item	Description	Material ⁽¹⁾	EN/DIN	Comparable ASTM
01	Shaft	Duplex SS Martensitic SS Aluminium Bronze Monel K500* Hastelloy-C*	1.4462, EN 10088 1.4057, EN 10088 CuAl10Ni5Fe4, EN/DIN 17665 NA 18, BS 3076 -	A 182, Grade F51 A 276, Grade 431 B 150, C63000 - B 547, N10276
02	Bush	Bronze		
03	O-ring	EPDM NBR FPM		
04	Body	Ductile Iron Ductile Iron (low temp.) Carbon Steel	JS 1030, EN 1563 JS 1049, EN 1563 1.0619, EN 10213	A 395, 60-40-18 - A 216, WCB
05	Bearing	St. / PTFE Lining Bronze / PTFE Lining		
06	Conical pin	See ITEM 01	See ITEM 01	See ITEM 01
07	Disc	Duplex SS Martensitic SS Aluminium Bronze Hastelloy-C* CuNi	1.4462, EN 10088 1.4057, EN 10088 G-CuAl10Ni, DIN 1714 - 2.0835, DIN 17658	A 182, Grade F51 A 276, Grade 431 B 148, C95800 A 494, CW-12MW -
08	Shaft	See ITEM 01	See ITEM 01	See ITEM 01
09	Lining	EPDM NBR FPM		
10	Sealing ring	Cu		
11	Plug	St./Zn5C		

⁽¹⁾ Other materials on request⁽²⁾ For DN 250 and DN 300

DIMENSIONS - EVMS 350 (14")

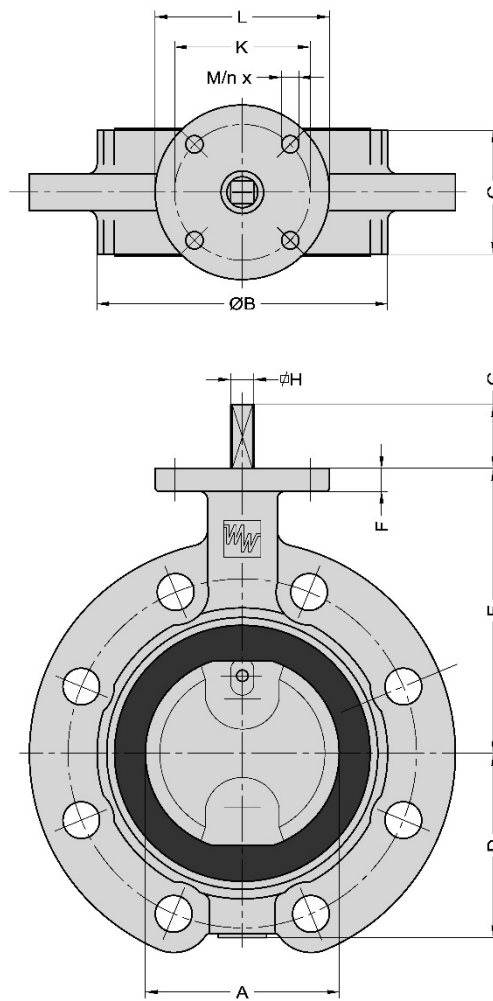

DN	NPS	A	B	C	D	E	F	G	H	ISO 5211	K	L	M	n	MASS ±kg
350	14"	336	405	78	236	315	15	45	24	F10	102	125	11	4	45

PARTS LIST - EVMS 400-1000 (16"-40")

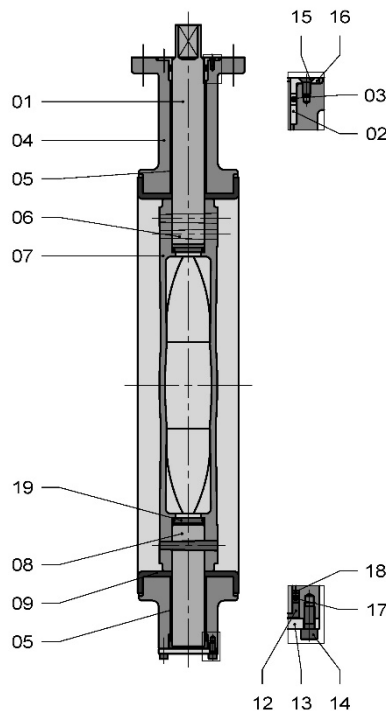

Item	Description	Material ⁽¹⁾	EN/DIN	Comparable ASTM
01	Shaft	Duplex SS Martensitic SS Aluminium Bronze Monel K500* Hastelloy-C*	1.4462, EN 10088 1.4057, EN 10088 CuAl10Ni5Fe4, EN/DIN 17665 NA 18, BS 3076 -	A 182, Grade F51 A 276, Grade 431 B 150, C63000 - B 547, N10276
02	Bush	Bronze		
03	O-ring	EPDM NBR FPM		
04	Body	Ductile Iron Ductile Iron (low temp.) Carbon Steel	JS 1030, EN 1563 JS 1049, EN 1563 1.1019, EN 10213	A 395, 60-40-18 - A 216, WCB
05	Bearing	St. / PTFE Lining Bronze / PTFE Lining		
06	Conical pin	See ITEM 01	See ITEM 01	See ITEM 01
07	Disc	Austenitic SS ⁽²⁾ Duplex SS ⁽³⁾ Martensitic SS ⁽⁴⁾ Ductile Iron / Rilsan coated Aluminium Bronze Hastelloy-C* ⁽⁵⁾ CuNi ⁽⁵⁾	1.4408, EN 10213 1.4462, EN 10088 1.4057, EN 10088 JS 1030, EN 1563 G-CuAl10Ni, DIN 1714 - 2.0835, DIN 17658	A 351, CF8M A 182, Grade F51 A 276, Grade 431 A 395, 60-40-18 B 148, C95800 A 494, CW-12MW -
08	Shaft	See ITEM 01	See ITEM 01	See ITEM 01
09	Lining	EPDM NBR FPM		
12	Axial bearing	Bronze		
13	Cover plate	St./Zn5C		
14	Cylinder head screw	St./Zn5C		
15	Counter sunk screw	St./Zn5C		
16	Collar bearing	Bronze		
18	Ring	Bronze		
19	Sealing plate	St./NBR St./FPM		

⁽¹⁾ Other materials on request⁽²⁾ for \geq DN 500⁽³⁾ forged \leq DN 450, casted \geq DN 500, material 1.4517, EN 10213 (ASTM A 351, CD-4MCu)⁽⁴⁾ forged \leq DN 450⁽⁵⁾ \leq DN 500

DIMENSIONS - EVMS 400-1000 (16"-40")

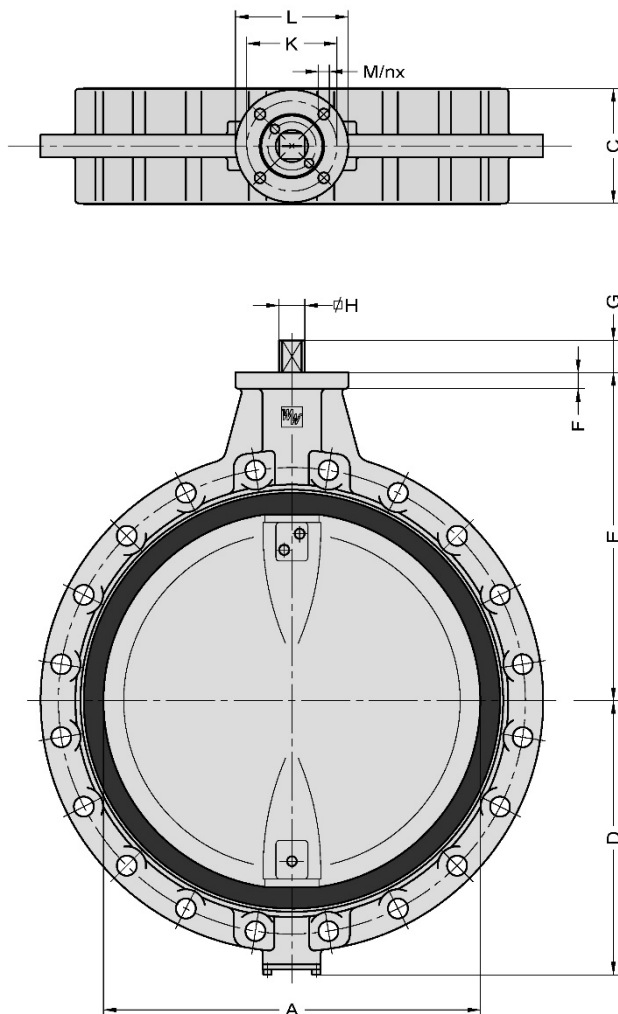

DN	NPS	A	C	D	E	F	G	H	ISO 5211	K	L	M	n	MASS ±kg
400	16"	386	102	308	363	25	50	30	F14	140	175	17	4	85
450	18"	436	114	334	388	25	50	30	F14	140	175	17	4	100
500	20"	486	127	360	413	25	50	30	F14	140	175	17	4	135
600	24"	586	154	426	510	25	50	40	F14	140	175	17	4	200
700	28"	686	165	499	560	25	60	46	F16	165	210	21	4	315
750	30"	736	190	520	585	25	60	46	F16	165	210	21	4	340
800	32"	786	190	549	610	25	60	46	F16	165	210	21	4	365
900	36"	886	203	625	690	30	90	60	F25	254	300	17	8	500
1000	40"	986	216	685	740	30	90	60	F25	254	350	17	8	670
1000	40"	986	216	685	740	30	90	60	F30	298	350	21	8	670